

SUPRA 1mm

Stainless Steel
Single Wall
Chimney System

Diameters \varnothing 400mm-600mm

For condensing application (with seals)

Can be used as a rigid chimney liner within a masonry shaft
(without seals)

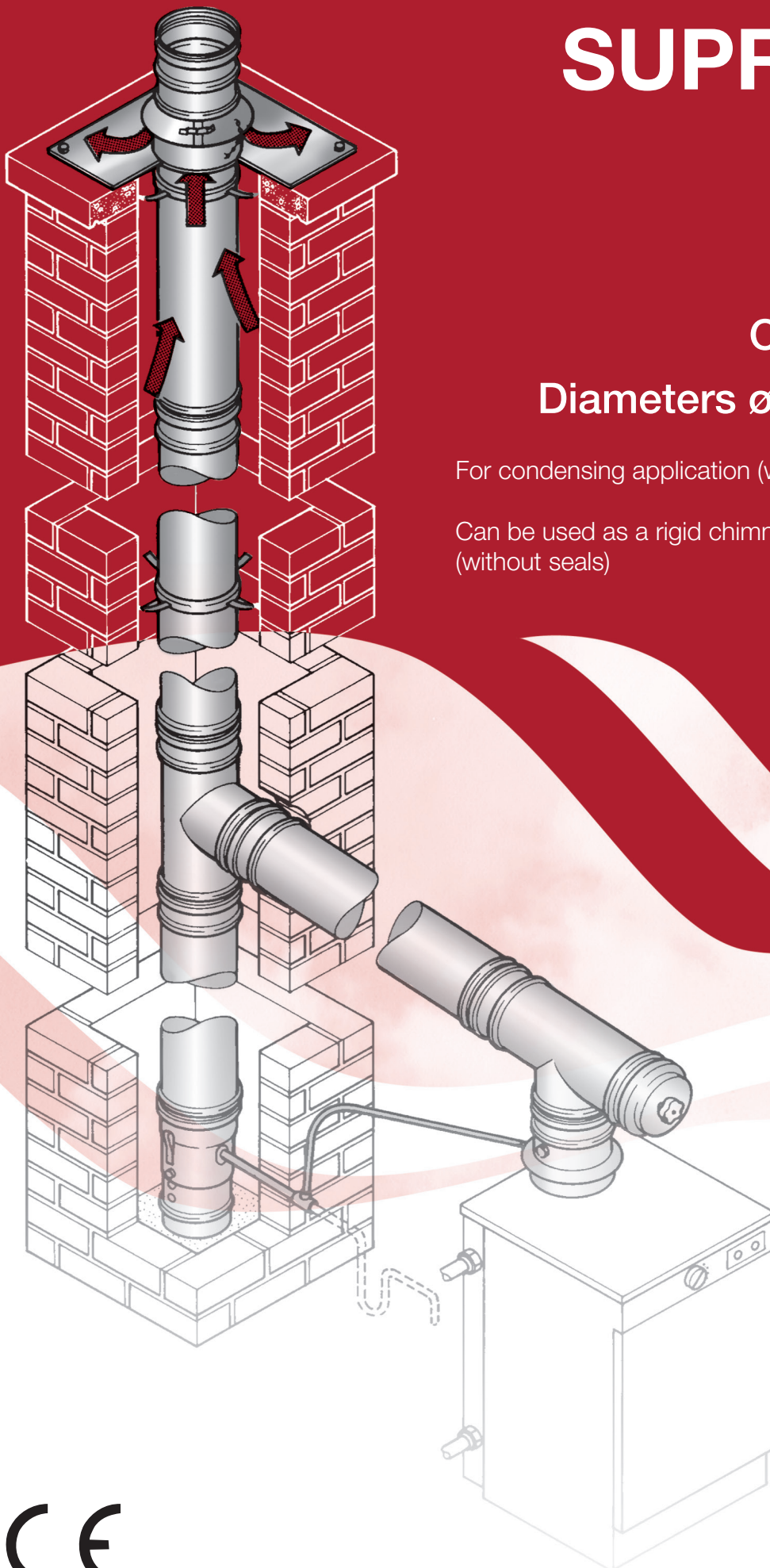

CE

SFU
flues & chimneys

PRODUCT INFORMATION

The Supra chimney system range is specifically designed to meet the demands of the latest high efficiency condensing heating appliances. Supra is supplied complete with factory fitted and bonded elastomer triple lip seals, offering peace of mind and reduced installation time for the installer.

INTRODUCTION

Supra is a single-wall pre-fabricated stainless steel flue system, primarily designed for gas and kerosene (28Sec) oil fired appliances, which produce condensates and positive pressure conditions as a function of their operation, such as high efficiency condensing appliances.

DESCRIPTION

Supra is manufactured in 3 diameters ranging from 400mm to 600mm and consists of a range of lengths and fittings which simply push-fit together, and are then secured with a Locking Band. The entire system is manufactured from corrosion resistant grade 316L (1.4404:X2CrNiMo 17-12-2) stainless steel and is manufactured using a fully welded construction and precision formed close tolerance joints.

Supra has been specifically designed for condensing applications and **are** supplied complete with factory fitted and bonded elastomer seals.

Product sizes from 400mm to 600mm inclusive are manufactured from 1mm 316L material.

The Supra product is available with a wide range of support components that cater for both lateral and vertical structural loading of the product. SFL does not recommend any other system of support being used with the Supra product, unless approved by SFL prior to installation.

Application

The standard Supra product is primarily designed for internal applications and for use on high efficiency gas / kerosene fired condensing appliances and for applications where the chimney could be under positive pressure conditions not exceeding 200Pa at a maximum flue gas temperature of 200°C. Supra can also be used as a rigid chimney liner within a masonry chimney.

When fluing condensing appliances and where the chimney is external to the building, there is a risk that the condensates could freeze. In such cases, SFL would recommend that a twin wall insulated product such as Nova is used to prevent this. Regulations require all domestic external flue runs over 3m are to be made from twin wall insulated product manufactured with a stainless steel liner.

Care should be taken where there is a risk of accidental human contact with Supra. Although most condensing appliance produce flue gas temperatures in the region of 30-50°C, it is possible that in non-condensing mode the flue gases can achieve much higher temperatures. For instances where the flue gas temperature of the appliance can rise above 70°C and there is the possibility of accidental human contact, a twin wall insulated product such as Nova should be used.

Supra can also be used as a rigid chimney liner within a masonry chimney. Where used in a lining capacity, SUPRA can be used with the seals removed and is designated as sootfire resistant (G) whilst resistant to water diffusion vapour and condensate penetration (W). The pressure resistance becomes N1 (40Pa) for atmospheric draught appliances. Applications include condensing biomass boilers and other situations where condensation is expected from a natural draught appliance.



Approvals

The Supra product is CE certified to BS EN 1856-1 & 2 certificate No. 0086-CPD-496040 & 0086-CPD-559419 to the performance designations as detailed in Table A below.

Table A

Supra product designations to BS EN 1856-1/2							
Supra	BS EN 1856-1	T200	P1	W	V2	L50050	O(300)
Supra 1.0	BS EN 1856-1	T450	N1	D	V2	L50100	G(450)
Supra 1.0 (S)	BS EN 1856-1	T200	P1	W	V2	L50100	O(300)
Supra	BS EN 1856-2	T200	P1	W	V2	L50050	O
Supra (No Seals)	BS EN 1856-2	T450	N1	D	V2	L50050	G(450)
Supra 1.0	BS EN 1856-2	T450	N1	D	V2	L50100	G
Supra 1.0 (S)	BS EN 1856-2	T200	P1	W	V2	L50100	O

Standard number	↑
Temperature class	↑
Pressure class	↑
Condense resistance D=dry W=wet	↑
Corrosion class	↑
Material specification Liner grade 316L Liner thickness: 0.5mm / 1.0mm	↑
Sootfire resistance G=yes O=no	↑

Product to EN1856-2 relate to chimney liners within a non-combustible shaft.
(S) Denotes fitted Seals.

Quality

All components are manufactured under a quality assurance scheme, certificate No. FM 557622, administered by British Standards in accordance with BS EN 9001: 2008. In addition SFL operate a CE approved factory production control system as required under the Construction Products Directive 93/68/EEC.

Installation / Regulations

Connection to an appliance which is not connected to the fuel supply, may be carried out by a competent person. However, connection to an appliance that is connected to the fuel supply MUST be carried out by an approved and registered heating engineer, e.g. Gas Safe, HETAS (Solid Fuel) or OFTEC (Oil).

The Installation of the Supra product must be in accordance with local building regulations and associated National Standards and Code of Practice. Relevant standards are as follows:-

Document J - DOE Building Regulations
Section F - Building Standards (Scotland)
Section L - Building Regulations (Northern Ireland)
Solid Fuel & Oil Fired Appliances: BS EN15287-1:2007
Domestic Gas Installations: BS5440: Part 1: 2008

Where Supra is used to reline an existing stack, it is imperative that the product is not supported by suspending from the top of the stack. In all instances the liner must be lowered down the stack using a Support Length at the bottom. Location Bands must then be used at intervals not exceeding 3.0 metres. The Location Bands are to be secured underneath a joint and are designed to centrally locate and brace the system when lowered into an existing chimney or shaft. When required, the Location Bands can be manufactured to bespoke dimensions provided by the customer to suit the required chimney / shaft dimensions.

For condensing (WET) applications it is important that horizontal sloping runs are angled not less than 3° to the horizontal where head room is limited, but preferably 5°. Various components are available to facilitate either a 3° or 5° incline from the horizontal. Drainage components MUST be used strategically within the system to facilitate the removal of condensation, see Fig 3 (P11). Prior to making the joint, ensure that both mating ends are clean and free of dirt and apply a generous amount of SFL Seal Lubricant around the face of the seal to aid installation.

Commercial Applications

The Supra Product is suitable for commercial applications up to and including 600ID. Due to the complexity of most installations, SFL can manufacture to order bespoke components including special angled elbows, tees and multi-inlet manifolds. Please forward your requirements complete with detailed dimensioned drawing to SFL Technical Department who will assess your requirements.

SFL also employ state of the art software to model the thermodynamic and flow characteristics of the proposed system, allowing the most economic system design to be achieved. All designs are calculated in accordance with EN 13384 parts 1 & 2. SFL can also offer advice on the Clean Air Act requirements and calculate chimney heights to the requirement of the Clean Air Act Memorandum. For further information please contact SFL Technical Department.

Elastomer Seal (P1 / W Applications)

The Elastomer Seal is located in the recess of the female end of the Supra chimney system as detailed in Fig 1. Where Supra is being used for condensing (WET) / positive pressure (P1) applications up to 200Pa at a maximum flue gas temperature of 200°C, Elastomer Seals MUST be fitted at each joint within the system.

Note: Joint Seals are only suitable for gas and 28Sec (Kerosene) applications within the above limits.

Where Elastomer Seals are being used, the chimney system must be installed with a minimum of 3° or preferably 5° incline to the horizontal to ensure adequate back drainage of condensation. Failure to maintain an adequate incline and lack of drainage component in the system may lead to premature failure of the product / seals.

SUPRA JOINTING DETAILS

Fig 1

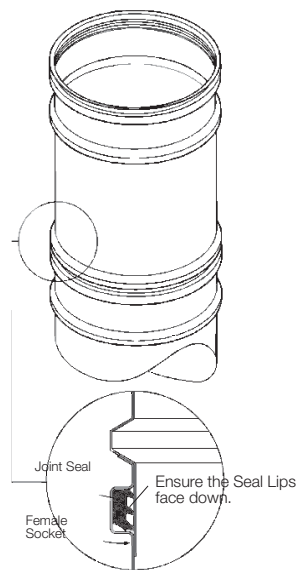
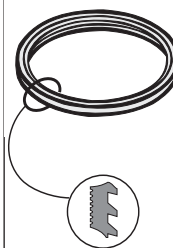

Fig 2



Elastomer Seals
Supplied bonded on Standard Supra.
Replacement seals for all diameters are
given below.

Seal Size	Code Number
400mm	4006340
500mm	4006350
600mm	4006360

Seal lubricant (P1/W)



This must be applied around the circumference of the fitted seal to provide a lubricated interface between the seal and the liner when the product is used for positive pressure and wet applications.

	Code Number
Seal Lubricant (250ml)	3107500

Only SFL lubricant should be used as it has been specially formulated for use with both silicone and EPDM seal materials. Failure to use SFL lubricant when installing seals in Supra product may invalidate the product warranty.

LENGTHS

Available in 'nominal' installed lengths as detailed in the table below;

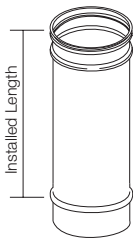

Installed Length (mm)				
80mm- 150mm	988	458	193	
180mm- 600mm	969	459	204	
Lengths				
Code Number				
400mm	4020140	4020240	4020340	
500mm	4020150	4020250	4020350	
600mm	4020160	4020260	4020360	

Locking Bands

This component must be used on every joint between components. Needs to be ordered separately.

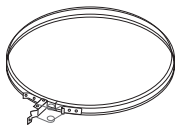

Size	Code Number
400mm	4027040
500mm	4027050
600mm	4027060

Inspection Length

Designed to be installed within the system to allow access for inspection and cleaning. The door closes on an elastomer seal to provide a water and pressure resistant joint and must only be used where the flue gas temperature will NOT exceed 200°C. For high temperature applications both the inner and outer door seal must be removed prior to installation.

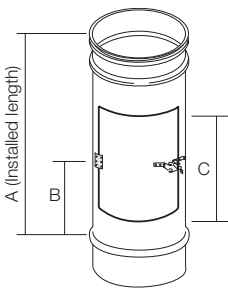

Size	Code No.	A	B	C
400mm	4021040	289	127	170
500mm	4021050	289	127	170
600mm	4021060	289	127	170

Adjustable Length

Designed to be used to make up a required length between two components. It should be used with a standard length which MUST be ordered separately. It can also be inserted into the female end of other components, but however applied, must engage a depth equivalent to at least half the diameter of the Supra being used. Adjustable Length (80mm - 350mm) are also supplied with a special Locking Band and Seal which must be used for condensing applications. For sizes above 350mm, the A Locking Band and Seal MUST be ordered separately. See Installation Instructions on page 11 for further details.

75mm minimum to 230mm maximum installed length

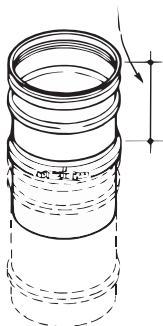

Size	Code Number
400mm	4024440
500mm	4024450
600mm	4024460

Adjustable Locking Band and Seal (400mm - 600mm Supra)

Required for above sizes when used on wet / positive pressure systems.

Size	Code Number
400mm	4007240
500mm	4007250
600mm	4007260

TEES

90° Tee

Used to provide a 90° connection in a system run or can be used as an access / inspection point when used with a Locking Plug

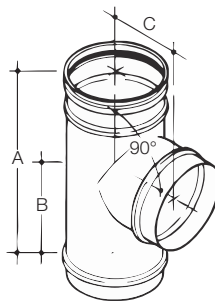

Size	Code No.	A	B	C
400mm	4020540	969	466	303
500mm	4020550	969	466	303
600mm	4020560	969	466	477

93° Equal Tee

The tee is provided with a 3° connection on the branch to allow for condensate drainage where headroom is limited.

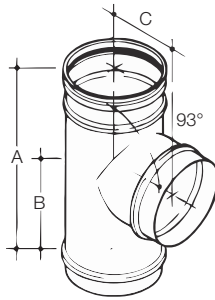

Size	Code No.	A	B	C
400mm				
500mm				
600mm				

N/A

95° Equal Tee

The tee is provided with a 5° connection on the branch to allow for condensate drainage. Can be used at the base of a vertical stack or to facilitate a 5° incline.

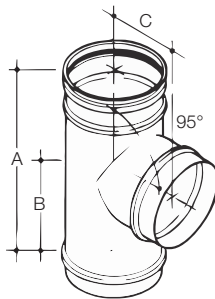

Size	Code No.	A	B	C
400mm	4021940	969	466	303
500mm	4021950	969	466	303
600mm	4021960	969	466	477

135° Equal Tee

Used to provide a 45° connection in a system run or as the entry point to a chimney. Can be used as an access / inspection point when used with a Locking Plug or as a drain when fitted with a Condensate Collector.

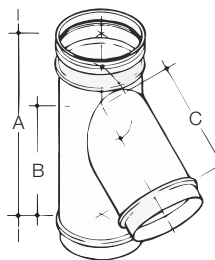

Size	Code No.	A	B	C
400mm	4022240	969	679	521
500mm	4022250	969	730	642
600mm	4022260	969	780	762

135° Tee and 45° Elbow configuration

Used to provide a 90° connection in a system run or can be used as an access / inspection point when used with a Locking Plug

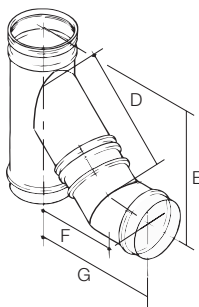

Size	D	E	F	G
400mm	697	783	493	632
500mm	839	832	593	753
600mm	979	881	692	872

TEE ACCESSORIES



Locking Plug

Used to close off the branch or base of a tee or the end of a header/manifold. Held in position with a Locking band.

Size	Code Number	A
400mm	4024940	77
500mm	4024950	77
600mm	4024960	77

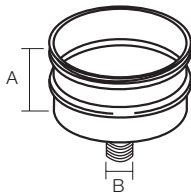

Condensate Collector

Used at the bottom of a vertical run, usually under a Tee, to facilitate drainage of condensates from the system. The component includes a stainless steel BSP connection to allow drainage pipework to be connected by others.

Size	Code Number	A	B
400mm	4024340	77	2"
500mm	4024350	77	2"
600mm	4024360	77	2"

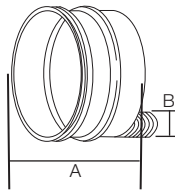

Offset Condensate Collector

As above but with drain on rim.

Size	Code Number	A	B
400mm	4026940	77	2"
500mm	4026950	77	2"
600mm	4026960	77	2"

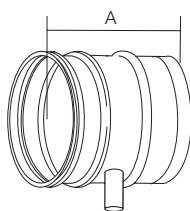

Horizontal Duct Drain

Used as a drainage point on the end of an inclined manifold or inclined run. Incorporates an internal condensate dam and BSP stainless steel connection for condensate drainage. Also supplied with fixed end cap. Note: The Cap cannot be removed.

100-350: 1" BSP
400-600: 2" BSP

With Cap

Size	Code No.	A
400mm	4021840	200
500mm	4021850	200
600mm	4021860	200

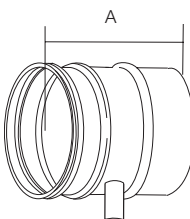

Without Cap

Size	Code No.	A
400mm	4020840	200
500mm	4020850	200
600mm	4020860	200

100-350: 1" BSP
400-600: 2" BSP

ELBOWS

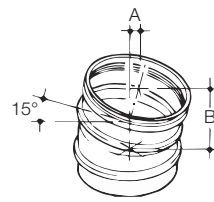

15° Elbow

Used to provide a 15° change of direction from the vertical.

Size	Code No.	A	B
400mm	4022540	31	197
500mm	4022550	33	211
600mm	4022560	34	224

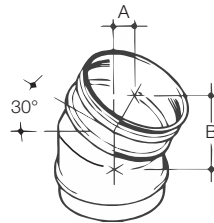

30° Elbow

Used to provide a 30° change of direction from the vertical.

Size	Code No.	A	B
400mm	4022440	74	237
500mm	4022450	80	262
600mm	4022460	87	286

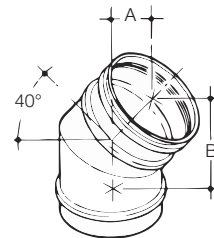

40° Elbow

Used to provide a 40° change of direction from the vertical.

Size	Code No.	A	B
400mm	4029840	113	274
500mm	4029850	127	311
600mm	4029860	139	346

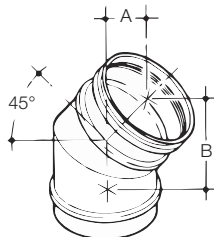

45° Elbow

Used to provide a 45° change of direction from the vertical.

Size	Code No.	A	B
400mm	4022340	124	263
500mm	4022350	139	299
600mm	4022360	153	333

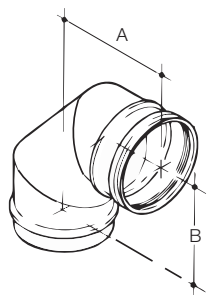

85° Elbow

Used to provide a 85° change of direction from the vertical. Also for use on condensing systems to allow a 5° incline to aid drainage of condensate back through the system.

Size	Code No.	A	B
400mm	4022740	343	338
500mm	4022750	388	386
600mm	4022760	434	437

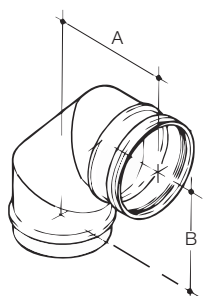

87° Elbow

Used to provide a 87° change of direction from the vertical. Also for use on condensing systems to allow a 3° incline to aid drainage of condensate back through the system where headroom is minimal. No standard code-made as a special.

Size	Code No.	A	B
400mm			
500mm	N/A - Price on application		
600mm			

90° Elbow

Used to provide a 90° change of direction from the vertical.

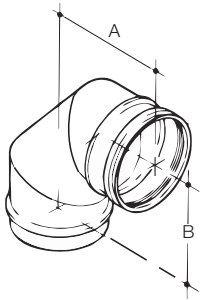

Size	Code No.	A	B
400mm	4022840	357	320
500mm	4022850	405	368
600mm	4022860	452	415

ADAPTORS

Appliance Adaptor

Used to connect the Supra product to the appliance. The interface between the Adaptor and the appliance outlet should be sealed with silicon sealant when used on condensing appliances.

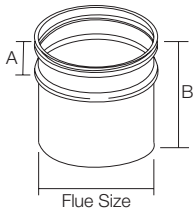

Size	Code No.	A	B
400mm	4029340	42	197
500mm	4029350	42	197
600mm	4029360	42	197

Appliance Adaptor with Condensate Trap

Used to connect the Supra product to the appliance and drain condensate from the system where used on high efficiency and condensing appliances. The interface between the Adaptor and the appliance outlet should be sealed with silicon sealant. The design helps divert condensates through a 15mm OD stainless steel tube to which a drain hose can be connected, prior to entering the appliance.

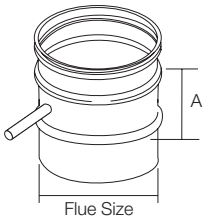

Positioned as an in-line condensate appliance adaptor

Size	Code No.	A
400mm	4021440	130
500mm	4021450	130
600mm	4021460	130

SUPPORT COMPONENTS

Bracing Bracket

Used to provide lateral stability back to support structure. This component must only be used with rigid stays and can be fitted anywhere on the pipe other than between the swages. Structural calculations must be made for each application. Rigid stays must be connected to the three fixing points of this three part component. The hole diameters for the M6 nuts and bolts are 7mm. Constructed from stainless steel.



Size	A	Code Number
400mm	402	4069240
500mm	502	4069250
600mm	602	4069260

Support Plate

Consists of a stainless steel plate with a three part support collar. The collar rests on the plate and is located under the bead/swage at a joint between components. The three fixing points of the collar rest on the plate, the hole in which being large enough to permit the passage of the swages of the Supra construction.

The plate must be adequately supported and secured to an adjacent structure. This component can also be used in conjunction with a Support Length, but the collar would be discarded for this application.

This component or a Wall Support MUST ALWAYS be used above an Adjustable Length where applied in a vertical application, or where the Adjustable Length would be otherwise liable to load. The maximum length which can be supported by this component is 30 metres.

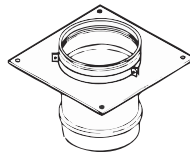
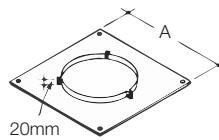

Size	A	Code Number
400mm	550	4051140
500mm	650	4051150
600mm	750	4051160

Wall Band

To be used at intervals not exceeding 2.5 metres to provide lateral stability for both vertical and horizontal applications within the system. Manufactured from stainless steel and suitable for both internal and external applications.

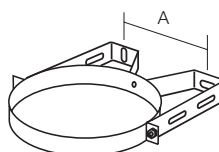
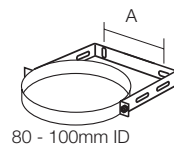

Size	A	Code Number
400mm	366	3115405
500mm	467	3115505
600mm	567	3115605

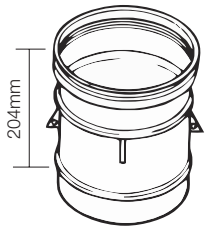

Support Length

The Support Length can serve two applications, firstly allowing a Supra liner to be lowered down a chimney and secondly as a Support Length when used with the Support Plate (less the collar). In all cases, ALL the lugs on the Support Length MUST be used when lowering the product. The maximum length of product that can be supported by the component is 30 metres.

Size	Code Number
400mm	4020440
500mm	4020450
600mm	4020460

Location Band

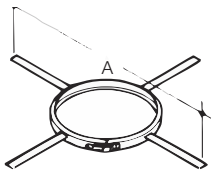

This component consists of a strap which must be secured underneath a joint. It has four equally located stainless steel "spokes" designed to centrally locate and brace the system where lowered into an existing chimney or shaft, and should be used at intervals not exceeding 3 metres. Constructed from stainless steel. Bespoke Location Bands to facilitate non-standard shafts can be manufactured to order. Please refer to SFL Technical Department with your requirement.

Size	A	Code Number
400mm	900	4017140
500mm	1000	4017150
600mm	1100	4017160

FLASHINGS AND WEATHERING

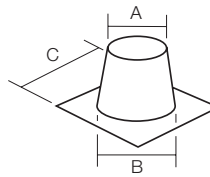

Flat Flashing

Size	Dimensions			Code Number
	A	B	C	
400mm	410	500	820	70000014
500mm	508	600	914	70000016
600mm	608	700	1015	70000018

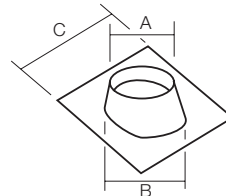

5° - 30° Angled Flashing

Size	Dimensions			Code Number
	A	B	C	
400mm	410	500	965	70053014
500mm	508	710	1010	70053016
600mm	608	824	1124	70053018

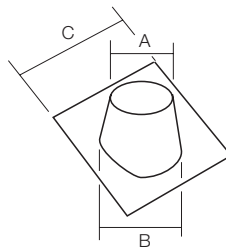

32° - 45° Angled Flashing

Size	Dimensions			Code Number
	A	B	C	
400mm	410	689	1219	70324514
500mm	508	831	1219	70324516
600mm	608	974	1219	70324518

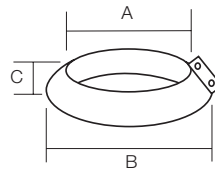

Storm Collar

TERMINALS AND TERMINATION

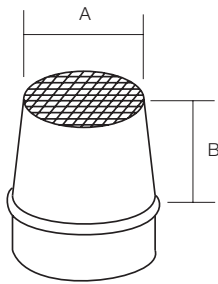

Tapered Top Stub and Mesh

This terminal should be used with gas condensing appliances as it offers least resistance to flow and help minimise the effects of pluming.

Size	Dimensions		Code Number
	A	B	
400mm	350	228	4026040
500mm	400	228	4026050
600mm	500	228	4026060

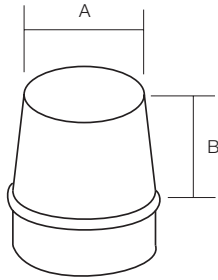

Tapered Top Stub

This terminal offers least resistance to the evacuation of flue gases and should only be used in accordance with the regulations.

Size	Dimensions		Code Number
	A	B	
400mm	350	228	4025840
500mm	400	228	4025850
600mm	500	228	4025860

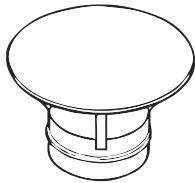

Rain Cap

This is a basic terminal that offers a degree of protection against rain ingress

Size	Code Number
400mm	4055240
500mm	4055250
600mm	4055260

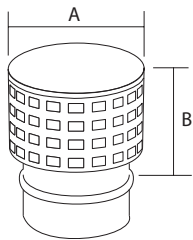

Gas Terminal

A terminal designed for use where Supra serves conventional gas fired equipment. Incorporates a bird screen/mesh. For condensing and positive pressure applications it is suggested to use a Tapered Top Stub with Mesh.

Size	Dimensions		Code Number
	A	B	
400mm	519	418	4006140
500mm	623	526	4006150
600mm	720	634	4006160

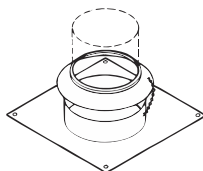

Supra Terminal Kit

The Supra Terminal Kit is designed for use where Supra is located within a chimney or shaft. It consists of a plate and a 100mm upstand (drum) which is traditionally weathered to the top of the shaft. The "drum" is significantly greater in diameter than the Supra product, to provide passive ventilation to the shaft / chimney. Four integral stainless steel straps centrally locate the Supra when the unit is lowered over the product. The projecting length of Supra above the "drum" is then rainproofed using the Storm Collar provided as part of the kit.

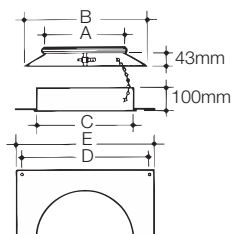

Size	Dimensions					Code Number
	A	B	C	D	E	
400mm	402	600	484	646	696	4005440
500mm	502	700	584	750	800	4005450
600mm	602	800	684	850	900	4005460

ELBOW OFFSET DIMENSIONS

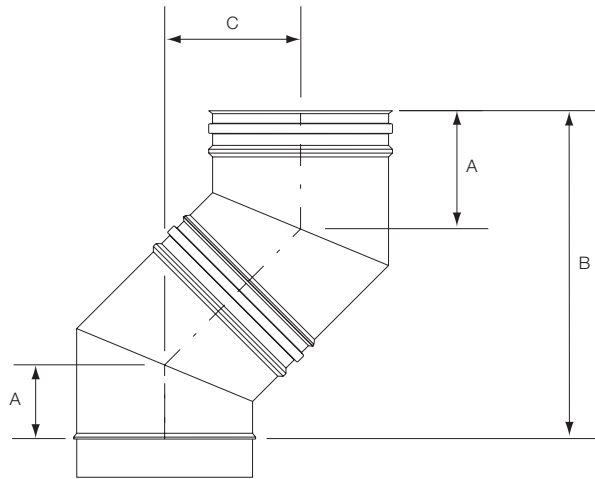

15° Offset

Size	Dimensions		
	A	B	C
400mm	117	393	52
500mm	126	426	56
600mm	133	448	59

30° Offset

Size	Dimensions		
	A	B	C
400mm	147	477	128
500mm	160	530	142
600mm	173	575	154

45° Offset

Size	Dimensions		
	A	B	C
400mm	176	537	222
500mm	197	608	254
600mm	217	677	281

TYPICAL CONDENSING APPLICATION

Fig. 3

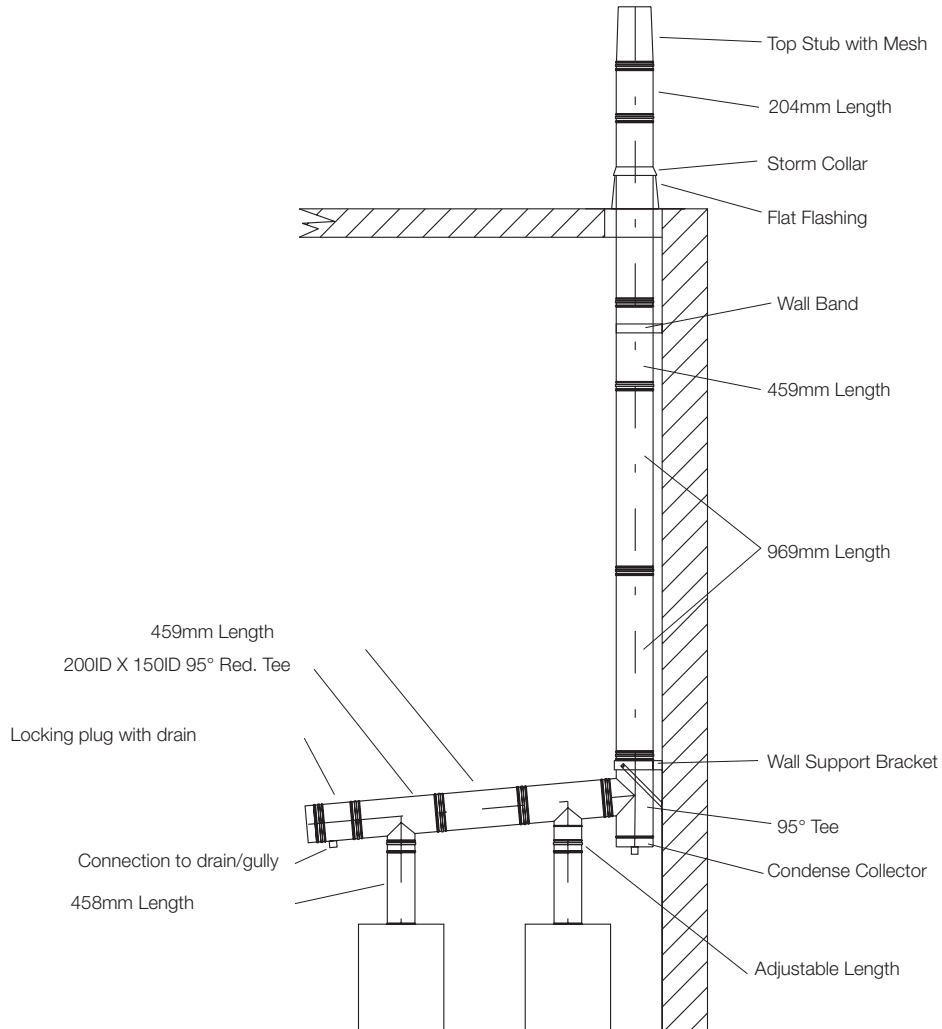

Mandatory Requirements

In all instances the requirements of the Building Regulations must be complied with and the appropriate references are: Document J of the DOE Building Regulations, Section F of the Building Standards (Scotland), Section L of the Building Regulations (Northern Ireland). Reference should also be made to the relevant British and European Standards governing the installation of flue and chimney products for the associated fuel and appliance types as detailed:

Solid Fuel and Oil Fired Applications: BS EN15287-1:2007
Domestic Gas Installations: BS5440: Part 1: 2008

Note: In the UK, connection to an appliance which is not connected to the fuel supply, may be carried out by a competent person. However, connection to an appliance that is connected to the fuel supply must be carried out by an approved and registered Heating Engineer, e.g. Gas Safe, HETAS (Solid Fuel) or OFTEC (Oil).

General

Supra must be applied such that the system complies with local / national Building Regulations and applicable standards. Where used on condensing appliances, the range of components will permit deliberate drainage of condensate, either back to the condensate removal components within the Supra system range, or through the heating appliance. No part of the flue system should be constructed to form an angle greater than 45° from the vertical. Although components are included that will permit horizontal applications, they should only be used for connection to the appliance. Where the system is being used for a condensing application, it is required that sloping connections run at an angle of 5° from the horizontal, using the Tees, Elbows and fittings designed for that purpose. If the system is to be used within an existing chimney or purpose designed shaft, the range of support components will allow such configurations and can also be used to provide an independent and fully supported system both inside and outside a building. Where Supra is installed in exposed applications or where the external run is greater than 3.0 metres, SFL would recommend that the Nova product is used.

Joining

The Supra system is joined by pushing the male end into the female end of the proceeding component, and then applying a Locking Band. The Locking Band must be installed so that the toggle is only closed from left to right. See Fig. 4. Ensure that both ends of the connecting joint are clean and free of dirt / grit.

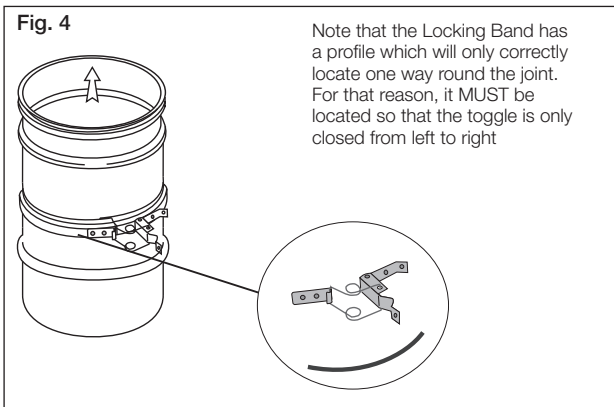

Note that the lips of the seal must be positioned as shown in Fig. 5. As the seal is designed to provide a secure grip to the male end of the component, SFL Seal Lubricating gel should be used to facilitate ease of installation and to prevent potential damage of the seal during installation.

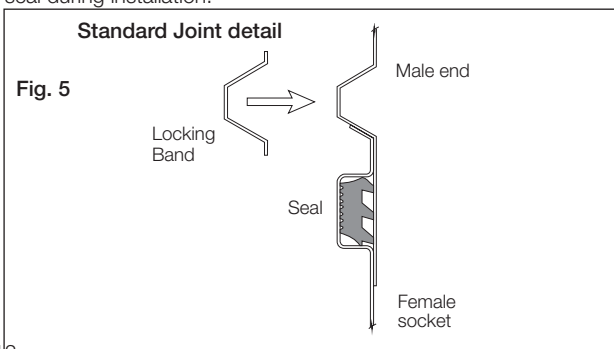

Adjustable Length

The Adjustable Length consists of a slip section of SUPRA, the lower non-beaded end of which is designed preferably to be located into a standard length. It can also be inserted into the female end of other components, but however applied, must engage to a depth equivalent to at least half of the diameter of the SUPRA being used. Where pressure and moisture resistance are required a special Locking Band & Seal is required to make the joint. These are supplied as standard on sizes up to and including 350mm. Above 350mm the Locking Band & Seal **MUST** be ordered separately.

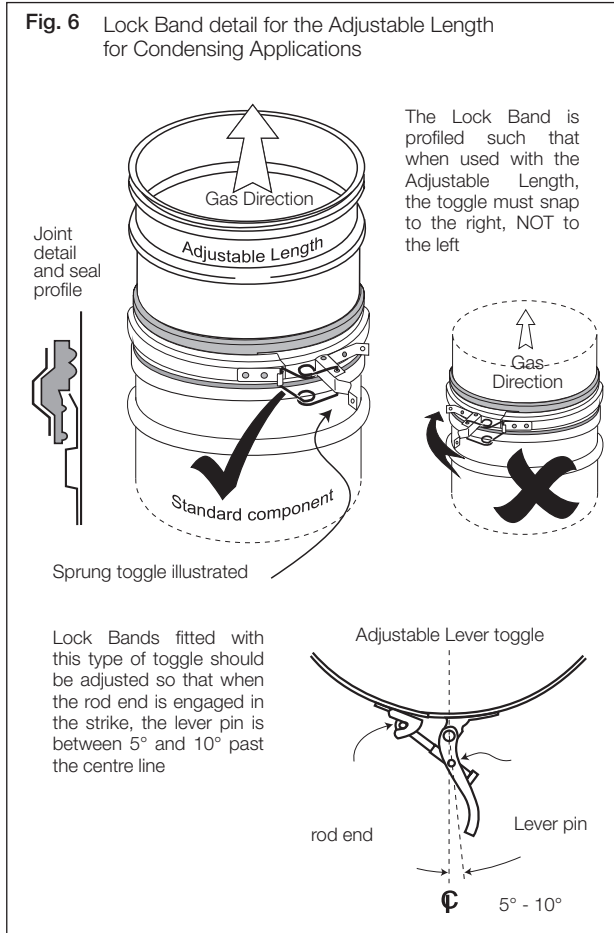

Fig. 6 illustrates the joint detail. Locate the seal over the socketed female end of the length or component female end **before** inserting the male end, and then pull the seal up so that the angled notch on its inside locates over the turned end of the female socket as shown. To facilitate easier assembly, apply SFL Joint Lubricant to the seal prior to installation. The Lock Band has two designs of toggle, either sprung or adjustable. If using the band with the adjustable toggle, it should be tensioned as shown in Fig. 6. Note that whichever type is applied, the profile of the Lock Band is such that it must only be applied one way round. If it is located incorrectly, the joint will be both insecure and inadequately sealed.

IMPORTANT - Adjustable Lengths

Adjustable Lengths are not load bearing and must be supported from above. Always ensure that either a Support Plate or Wall Support Bracket is used directly above the Adjustable Length to support the chimney products above.

Support

Supra must only be supported with the components in the system range. The maximum length of product run that can be supported by any component is 30 metres. Where lowered into an existing chimney or shaft, under no circumstances should the product be suspended from the top; always use a Support Length at the base of the chimney to lower from, which is designed for that purpose. The Wall Band and Bracing Bracket provide lateral stability only, and should be used at centres not exceeding 2.5 metres. The Location Band, used to centralise Supra where lowered into a chimney or shaft, should be used at intervals not exceeding 3 metres, and secured immediately underneath a joint. Where used as a liner, either a Support Plate or Wall Support must be used at the base to take the vertical load of the stack. Where the Supra product is free standing above the roof and its height exceeds 1.5 metres beyond the last support or the roof, a Bracing Bracket must be used and tied back to the structure.

Data Plate

It is a regulatory requirement that a data plate is to be completed, positioned and secured by the installer where a hearth, fireplace, flue or chimney is provided or extended. The data plate provides essential information regarding the performance, specification, designation and installation for the chimney system. The data plate is to be completed by the installer using an indelible ink and securely fixed in an unobtrusive but obvious position. Acceptable fixing positions would be next to the electricity consumer unit, water supply stop cock or gas meter within the building or by the chimney / hearth. The data plate detailed is provided by SFL, however many different data plates exist in the market and each design can be different and tailored to the supplying company. Some data plates contain more or less information than detailed below in Fig. 7, however it is a requirement that all data plates have to provide the essential information deemed necessary under the regulatory requirement, as follows:-

- Property address.
- Where the chimney / hearth is installed.
- What fuels the chimney is suitable for (firing capacity).
- Is the chimney suitable for condensing appliances / applications.
- Chimney internal diameter.
- Installers name and address.
- Date of installation.
- Distance to combustible material.
- Product designation of the chimney to EN 1443, if relevant.

Fig. 7

Provision for sweeping and cleaning

Adequate provision should be made for inspecting and cleaning the chimney system. This is particularly important for solid fuel applications. SFL would recommend that chimneys serving solid fuel appliances are swept as frequently as necessary but at least

IMPORTANT SAFETY INFORMATION		CE
This label must not be removed or covered		
Property Address: Park House, Nova Road, Barnstaple, Ex31 1ZZ		
The chimney installed in the		Are suitable for (Fuel Type)
<input type="checkbox"/> Ground Floor <input type="checkbox"/> Lounge <input checked="" type="checkbox"/> Kitchen <input type="checkbox"/> First Floor <input type="checkbox"/> Dining Room <input type="checkbox"/> Boiler Room		<input checked="" type="checkbox"/> Gas <input type="checkbox"/> Oil (... Sec) <input type="checkbox"/> Solid Fuel <input type="checkbox"/> All Suitable for condensing appliances <input checked="" type="checkbox"/> Yes <input type="checkbox"/> No
Chimney Designation to BS EN 1443		
Temperature	Pressure Capability	Condense Resistance
<input checked="" type="checkbox"/> T200 <input type="checkbox"/> T450 <input type="checkbox"/> T600	<input type="checkbox"/> N1 (40Pa @ 2.0 l.s ⁻¹ .m ²) <input type="checkbox"/> P1 (200Pa @ 0.006 l.s ⁻¹ .m ²) <input type="checkbox"/> H1 (5000Pa @ 0.006 l.s ⁻¹ .m ²)	<input checked="" type="checkbox"/> W (WET) <input type="checkbox"/> D (DRY)
<input checked="" type="checkbox"/> Internal diameter of chimney: 200 mm Chimney Product Brand: SFL Nova SM		Corrosion Resistance: <input type="checkbox"/> V1 <input type="checkbox"/> V2 <input type="checkbox"/> V3 <input checked="" type="checkbox"/> Vm Sootfire Resistance: <input type="checkbox"/> S (Yes) <input checked="" type="checkbox"/> O (No) Distance to combustible material (XX): 50 mm
Installation Details		
Company Name: Wonder Plumb Services		Installed by: A Plumber
Address: Unit X, Novaside Industrial Estate, Barnstaple, Devon, Ex31 2ZZ		Date of Installation: 3rd September 2006
Phone Number: 01271 00011222		
Important Information This chimney system must be cleaned and inspected on a regular basis. In any event, this should not be less than once per year and should be undertaken by an authorised sweep. Under no condition should black steel sweeping brushes or chemical chimney cleaners be used with this product. It is a requirement both under Building Regulations and CE that this plate is completed and installed within the guidelines contained therein.		
SFL, Pottington Business Park, Barnstaple, Devon, England EX311LZ		

twice a year and possibly three times a year if the appliance is subject to long periods of slumbering. Access component are made available within the range and should be installed to suit the installation, unless sweeping can be undertaken through the appliance.

It is important that a visual inspection of the chimney is undertaken at the same time to ensure all joints are sound and there is no evidence of a chimney fire having occurred.

Terminal Types

The Supra range offers a number of different terminal types to suit various applications. Where used on condensing appliances, the Top Stub with mesh would be preferable as this offers little additional resistance to the flue gases. The same Top Stub but without the mesh would also be the preferred option for solid fuel, providing there is a drainage point at the base of the chimney. As an alternative the Rain Cap could also be used to help reduce rain ingress into the chimney system. For gas fired appliances we would suggest that the Gas Terminal is used.

Testing

This is achieved by means of a flue flow test as detailed in BS5440: Part 1: 2008. This can be summarised as follows: After completing a visual and physical check of the system and joints, and ensuring adequate air supply for combustion has been provided in accordance with the appliance requirements, close all doors and windows in the room in which the appliance is installed. Carry out a flow visualization check using a smoke pellet that generates at least 5m³ of smoke in 30s by placing the smoke pellet in the intended location of the appliance. Ensure that there is discharge of smoke from the correct terminal only and no leakage into the room. When the chimney is tested, there should be:

- No significant escape of smoke from the appliance position.
- No seepage of smoke over the length of the chimney.
- A discharge of smoke from only the correct terminal.

If these conditions are not met, then the test has failed and all faults must be rectified and the system re-tested and passed before connection of the appliance to the fuel supply is undertaken. For further information please refer to the relevant standards and publications.

Note: A smoke test is subjective and by the nature of the product standards a chimney is allowed a degree of leakage as defined in BS EN 1856-1. For this reasons some wisps of smoke may be seen over the length of the chimney and this should not necessarily constitute a failure. It is therefore a matter of expert judgement as to whether significant leakage constitutes a failure. A product with a performance designation under EN 1856-1 with a leakage classification of N1 is allowed a maximum leakage rate of up to 2.01/s/m² at a positive pressure of 40Pa.

For further information and guidance please refer to Appendix E of the Building Regulations Part J.

Handling

The product is relatively easy to handle, but care should be taken when holding, fitting or assembling any part of the system. Users are advised to take suitable procurations, gloves etc., to avoid injury on any sharp exposed edges.

Chemical Contamination of Combustion Air

Under no circumstances should Supra be used where there is the possibility of chemical contamination of the combustion air. Environments where processes such as de-greasing and dry cleaning should be avoided as well as any other environment where low level contamination of the combustion air supply is possible. Such environment can lead to accelerated corrosion of the Supra system and premature failure of the product.

The information contained in this brochure was accurate at the date of publishing. However the company reserves the right to introduce at any time modifications and changes of details as may be necessary. To avoid any misunderstanding, interested parties should contact the company to confirm whether any material alterations have been made since the date of this brochure.



UK Sales and Customer & Export Services

SFL, Pottington Business Park, Barnstaple, Devon EX31 1LZ
Tel: 01271 326633 Fax: 01271 334303 www.sflchimneys.com info@sflchimneys.com



Consider your environment and download the latest electronic version of the Supra sales literature direct from our web site using the QR code above.

